

KAPTURE is a dual technology curtain sensor designed to protect access (such as doors, windows, etc.), balconies, and walls.

KAPTURE is able to create an electronic wall which, if it is crossed, generates an alarm. The detection is entrusted to a passive infrared sensor and a 24 GHz microwave. The combination of these two technologies, together with a sophisticated detection algorithm, allows to discriminate improperly alarms with care.

Equipped with anti-opening tamper, inclinometer and anti-masking, it is supplied with a practical wall bracket.

KAPTURE supports the innovative Wireless Walk Test and Programming System, composed of the VIEW SENSOR software and the mod. BT-LINK-S (supplied separately).

The sensor adapts to environmental conditions thanks to a sophisticated thermal compensation system.

READ CAREFULLY THIS MANUAL BEFORE INSTALL YOUR NEW ALARM SYSTEM. KEEP THIS MANUAL FOR FUTURE REFERENCE.

ONLY QUALIFIED TECHNICIAN MUST INSTALL THIS DEVICE. INSTALLER MUST FOLLOW CURRENT REGULATIONS.

THE MANUFACTURER SHALL NOT BE LIABLE FOR ANY IMPROPER USE OF THE PRODUCT, INCORRECT INSTALLATION OR FAILURE TO COMPLY WITH INSTRUCTIONS OF THIS MANUAL AND THE LAW REGARDING ELECTRICAL SYSTEMS.

1

DETECTION AREA

TOP VIEW
The sensor detects over an area with a maximum length of **12 m** and a width of **7.5 °** (Fig. A)

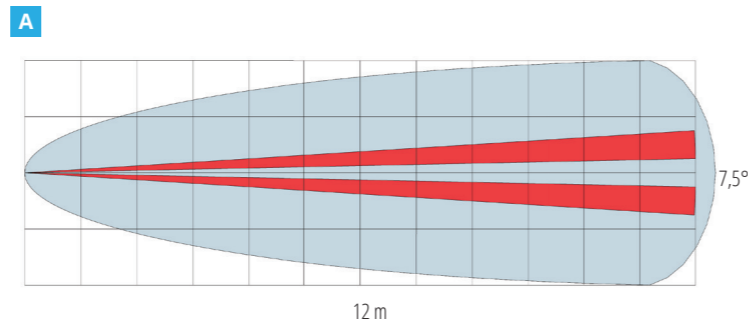

SIDE VIEW (installation at 2.2m high) (Fig. B)

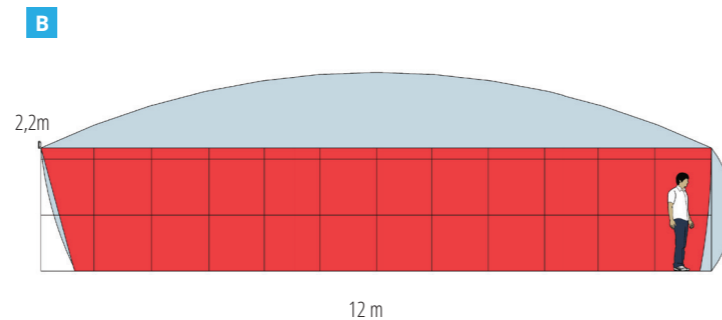

To change the detection area, change the inclination of the sensor and adjust the microwave and infrared ranges.

2

SIDE VIEW (installation at 3m height with inclined sensor) (fig C)

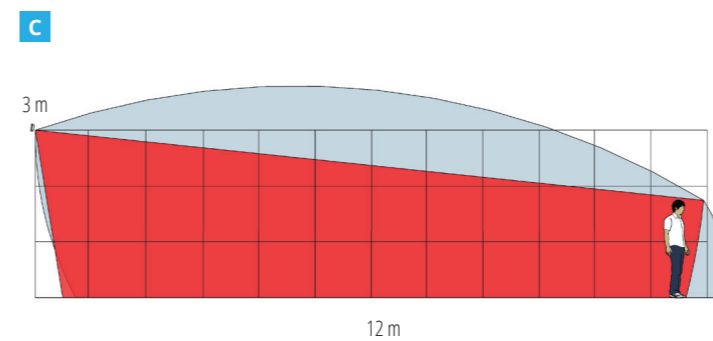

Mount the sensor vertically, without inclination to ensure maximum detection range, incline the sensor to delimit the coverage area.

INSTALLATION POSITION

The sensor can be installed directly on the wall or through the special L-shaped bracket. When the sensor is installed on the wall it is recommended to distance it from the wall to be protected so as not to obscure a sensitive element of the pyroelectric. Mount the sensor at a suitable distance from the wall as shown in figure E.

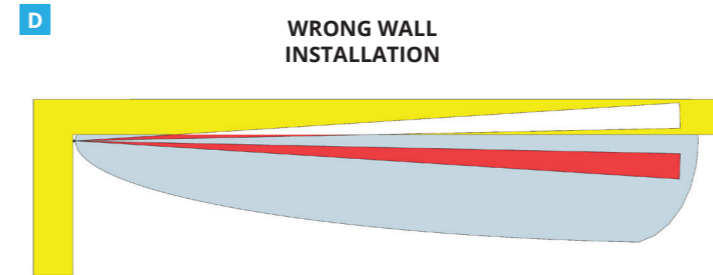

3

RIGHT WALL INSTALLATION

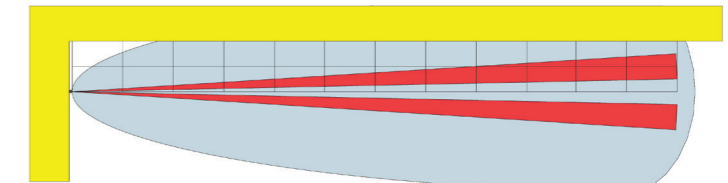

Position the sensor spaced from the wall following the rule:

- from 0 to 3 meters: mount the sensor about 20 cm from the wall
- from 3 to 6 meters: mount the sensor about 40 cm from the wall
- from 6 to 9 meters: mount the sensor about 60 cm from the wall
- from 9 to 12 meters: mount the sensor about 80 cm from the wall

The wall-mounting bracket is angled to ensure correct installation (fig.F)

INSTALLATION WITH BRACKET

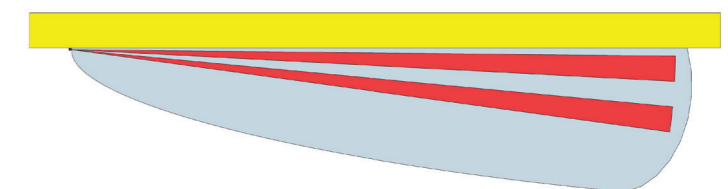

4

INSTALLATION WITH BRACKET

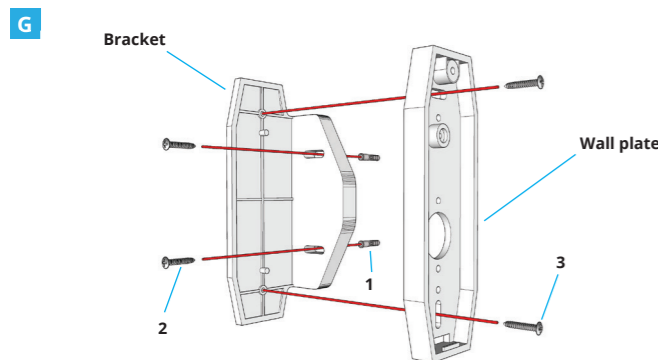

After defining the installation position of the sensor, install the L-shaped bracket following the indicated steps:

- make holes for fixing anchors (fig. G1)
- screw the bracket to the plugs (fig. G2)
- screw the wall plate to the bracket (fig. G3)
- screw the sensor to the wall plate (see next paragraph)

The bracket is characterized by tilting holes to allow the adjustment of the inclination of the sensor even after fixing.

To change the inclination of the sensor:

- loosen the screws (fig. G2)
- tilt the sensor
- tighten the screws (fig. G2)

Legend:

- G1) Fischer anchors 6mm (2pcs)
- G2) Milled head screw 3.5x40 mm (2pcs)
- G3) Cylindrical head screw 3.5x9.5 (2pcs)

5

INSTALLATION WITH WALL PLATE

- To install the sensor with the wall base, perform the following steps:
- make holes for fixing plugs (H1)
 - screw the wall base to the wall plugs (H2, H3)
 - break through the cable gland with a screwdriver and pass the wiring (H4)
 - screw the sensor to the wall base (H5)
 - close and tighten the sensor cover (H6)

SENSOR PARTS

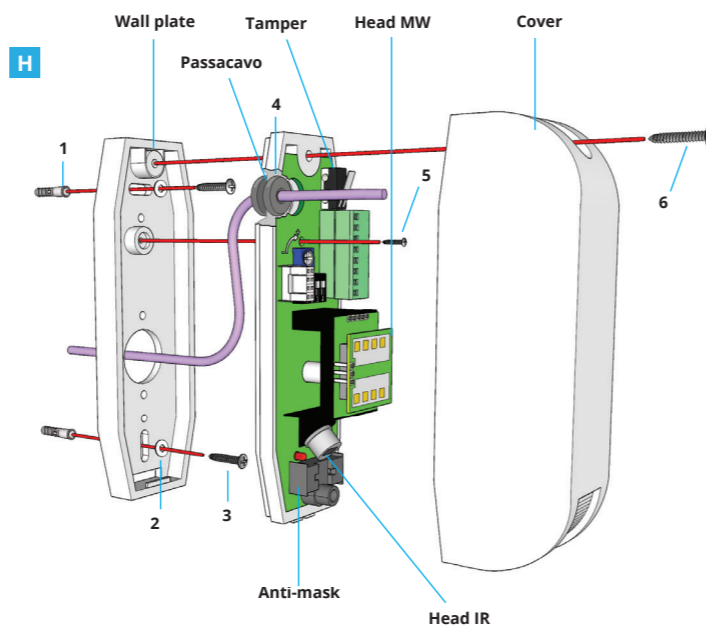

Legenda:

- H1) Fischer anchors 6mm (2pcs)
- H2) Washer 4 hole diameter 9 (2pcs)
- H3) Milled head screw 3.5x40 mm (2pcs)
- H4) Rubber cable gland (1pc)
- H5) 2.9x16 cylindrical head screw
- H6) Screw M 3x16

6

TECHNICAL

	KAPTURE-F
Power supply	12 V _{DC}
Absorption *	Stand-by: about 14 mA Alarm: about 12 mA
Autonomy (estimated) **	-
Stabilization Time (at power-up)	About 2 minutes (with LED blink)
Quiet Time between detections	-
Detection technologies	n. 1 Infrared head n. 1 Pulsed microwave @ 24 GHz head
Thermal compensation	Automatic compensation
-	-
-	-
Detection area	Max 12 linear meters (adjustable: 3 m + 12 m) 7.5 ° radial opening (IR) 105 ° radial opening (MW)
-	-
Sensitivity	Unified setup (trimmer) from 30% (min) to 100% (max)
Radio frequency / range	-
Anti-masking	Active infrared
Radio signals	-
Wired outputs	OptoMOS N.C. type (open an alarm occurs or if power is off) Max 40 V _{DC} / 100 mA Alarm Tamper Masking
LEDs	1 red LED (IR head detection) 1 blue alarm LED
Temperature / Humidity	-40 + +70 °C / 95 % (relative)
Case	ABS antiUV
Dimension (H x W x D)	128mm x 41mm x 48mm
Internal space for transmitter (H x W x D)	-
Accessories included	n. 1 wall bracket

* All the data are approximate, for sensor in NORMAL mode at operating temperature of 21 °C.
** Mean value for 10 detections-alarm/day + supervision.

7

COMPONENT DIAGRAM

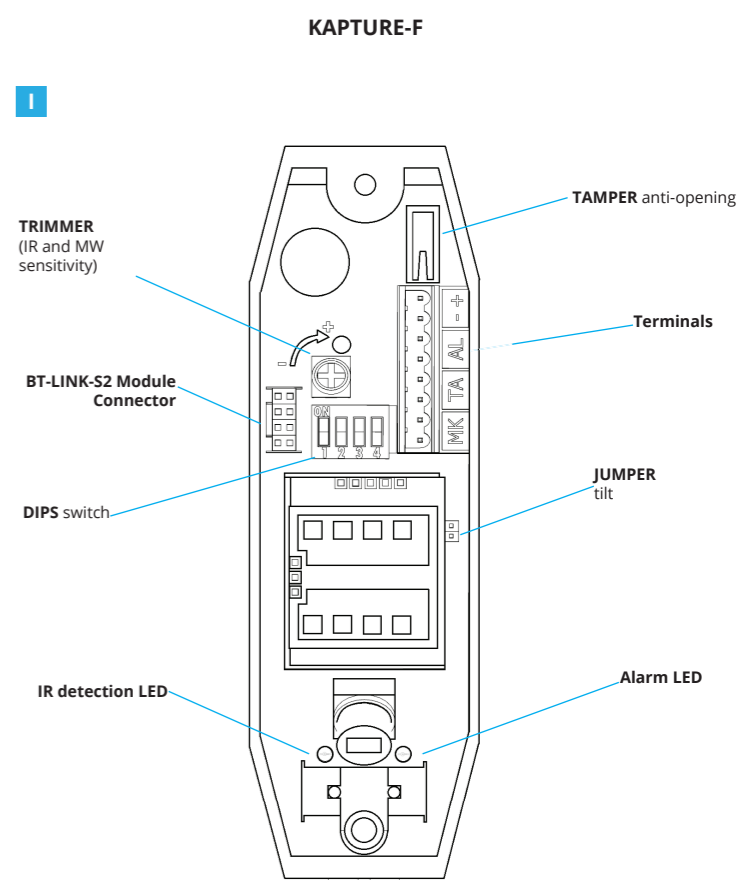

8

INSTALLATION (WHAT TO KNOW ABOUT)

THE SENSOR WORKS ONLY WITH THE COVER ON ITS PLACE !

AFTER EACH CHANGE TO DIP AND TRIMMER:

- (MANDATORY) PLACE THE COVER TO PERFORM TESTS
- WAIT AT LEAST 3 SECONDS (THE SENSOR READS NEW SETTINGS)

- The sensor has a IP54 protection level against dust and liquids. To maintain the IP54 level it is mandatory to insert the o-rings provided. If possible, it is suggested to install the sensor protected against weathering; do not point high pressure water jets to the sensor.
- Infrared detector is sensitive to the "amount of heat" produced by a moving body. The maximum range of the sensor (measured in meters) is referred to a human body. However the same "amount of heat" may be produced by a smaller body at lower distances (dog), or by a larger one at greater distances (vehicle).

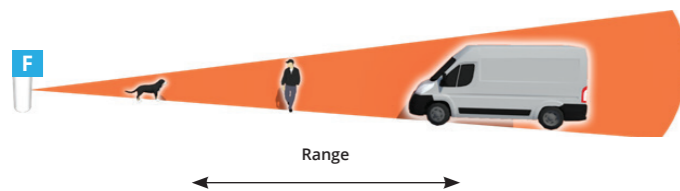

- Do not point the sensor towards unstable objects, such as: bushes, flags, tree branches, clothes hung, etc. This avoid unwanted detections.
- During adjustment, perform several detection tests to verify the correct working of the sensor. For best IR "sensitivity" adjustment, start setting the sensitivity to minimum (turn completely counter-clockwise the trimmers) and point the sensor downwards. Gradually increase the sensitivity and change the sensor orientation until obtain detection only inside the wanted area.
- The sensor may detect pets over 10Kg.
- In order to generate a useful signal for the IR head, at least two sectors must be crossed (FIG.A). Therefore it is advisable to orientate the head rotating it in an appropriate way so that conditions of crossing of a single sector are avoided.

POWER ON

If the sensor is already powered, before proceeding it is necessary to switch off the power supply and keep the anti-removal tamper pressed for about 3 seconds: in this way the circuit is completely discharged and the sensor can be started correctly. Supply the sensor: the sensor enters the "initialization" phase. The detection LEDs flash alternately for 30 seconds. It is important to leave the sensor "at rest" (no detection). At the end of the stabilization the LEDs turn off and the sensor can be used. To reset the sensor, disconnect the power supply and repeat the procedure described above.

9

VIEW SENSOR

VIEW SENSOR is the innovative application developed on Windows and Android platform that facilitates the installation of outdoor sensors. VIEW SENSOR allows you to adjust the sensor optimally to better define the area you want to protect, minimizing improper alarms. The application allows you to perform a walk-test completely innovative: through wireless connection you can view in real time on your device (PC, tablet or smartphone) the level of signal perceived by the individual heads, as well as configure the sensor without intervening manually. To use VIEWS SENSOR you need the optional BT-LINK-S module that connects to the sensor only for the duration of the walk-test and then is removed to be reused on other sensors.

Example of a mobile screen during the walk-test

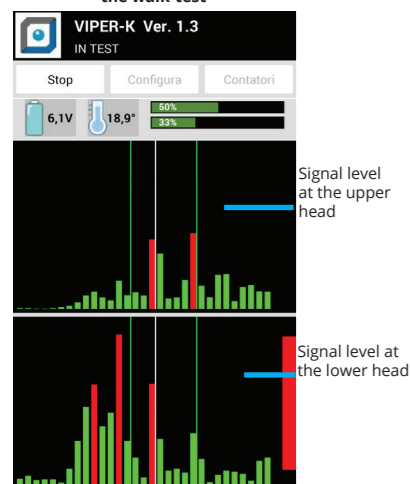

13

Example of a mobile screen during configuration

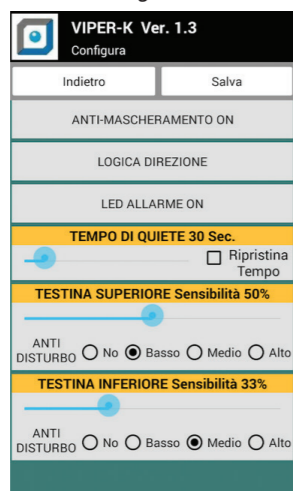

14

DIPS-SWITCH FUNCTIONS

To program the sensor, use the DIPS switches. The functions of the DIPS are described in the following paragraphs.

WARNING! When DIP3 = ON the sensor configuration is done via VIEW SENSOR, then some DIPS are not working (see DIP3).

	ON	←	OFF
ANTIMASKING ON TAMPER	ENABLED	4	DISABLED
REMOTE PROGRAMMING	ENABLED	3	DISABLED
ANTIMASKING	ENABLED	2	DISABLED
WALK-TEST	ENABLED	1	DISABLED

DIP 1 WALK-TEST

Through the DIP 1, the WALK-TEST is enabled on both heads for orientation and range adjustments. The sensor automatically exits from any WALK-TEST mode after approximately 15 minutes. During the WALK-TEST there are luminous signals to facilitate the operation; in NORMAL mode no signal is emitted, unless the alarm LED is activated (see "ACTIVE ALARM LED IN NORMAL MODE")

- **DIP1 = ON** Walk test activated
- **DIP1 = OFF** Walk test disabled, sensor in NORMAL MODE

Through VIEW SENSOR it is possible to easily execute a much more precise WALK-TEST, which allows to optimally configure the sensor.

DIP2 - ANTI-MASKING

The anti-masking device protects the sensor 24/24 in case an attacker wants to blind the sensor by covering it so as to prevent detection. Anti-masking does not work without the cover on the sensor.

- **DIP2 = OFF** Anti-masking disabled: no anti-masking protection
- **DIP2 = ON** Anti-masking enabled: you have an alarm mask when you cover the sensor in order to avoid detections.

The MASK alarm is activated if masking persists for more than one minute. Following the MASK alarm, the sensor returns to rest even if it remains masked. The anti-masking protection is always active (when enabled with **DIP2 = ON**) even when the central panel is switched off. Respect an area of approximately 30 cm in front of the sensor in which people must not stand more than a minute. Also, do not leave open doors, loose clothing or furniture items near the sensor. The anti-masking function is active with ambient temperature above 0 °C.

Through VIEW-SENSOR it is possible to extend the operating temperature of the anti-masking to values lower than 0 °C.

10

ADDITIONAL FUNCTIONALITIES (ONLY THROUGH VIEW SENSOR)

ANTIDISTURBANCE

This function increases the immunity to false alarms in particularly harsh outdoor environments, disturbed by sudden light reflections, changes in exposure to the sun, unstable objects (eg tree fronds, flat linen, etc ...). This setting can only be activated with VIEW SENSOR, with four different levels of intensity

INFRARED AND MICROWAVE INDEPENDENT ADJUSTMENT

Through VIEW SENSOR it is possible to calibrate the infrared and the microwave independently to obtain the maximum installation flexibility. For example, to increase the detected passage speed, it is possible to increase the sensitivity of the pyroelectric device, delimiting the sensor range with the microwave. It is important to remember that it is always a good idea to keep the pyroelectric more sensitive than the microwave, to always ensure correct detection in the area to be protected.

DIP3 - REMOTE PROGRAMMING

Select whether the sensor uses the hardware settings (trimmers and DIPS) when in OFF, or those sent by VIEW SENSOR when in ON.

- **DIP3 = ON REMOTE PROGRAMMING ENABLED** enables remote sensor programming via the VIEW SENSOR application available for mobile devices. This option provides greater flexibility in setting sensor parameters and allows real-time verification of changes to settings. For remote programming, the BT-LINK-S accessory, supplied separately, is required. With **DIP3** in the **ON** position the **DIP2** and the trimmer is deactivated because their functions are set via VIEW SENSOR. **DIPS 1 - 4** remain active. After memorizing a configuration using VIEW SENSOR, **DIP3** must remain **ON**, even after the WALK-TEST has ended. **If you place DIP3 in ON but you have not loaded a configuration via VIEW SENSOR, the sensor will use the hardware configuration**
- **DIP3 = OFF REMOTE PROGRAMMING DISABLED** the sensor configuration is done by DIPS and trimmers. This manual mainly explains the **HARDWARE** settings (via DIPS, trimmers and jumpers), for information on remote programming refer to the BT-LINK-S module manual and the VIEW SENSOR app.

ONCE USED SOFTWARE CONFIGURATION, LEAVE THE DIP7 = ON, OTHERWISE THE SENSOR RETURNS TO THE MANUAL SETTINGS

IF YOU DO NOT USE THE SOFTWARE CONFIGURATION SYSTEM, ALWAYS LEAVE THE DIP7 IN THE OFF POSITION

DIP4 - ANTIMASKING ON TAMPER

In the OFF position the sensor uses the MASK output to signal a masking alarm. If you can not or do not want to use this terminal, for example in the case where the antimasking is not managed by the control panel used, DIP8 can be set to ON and in case of masking alarm the sensor will use the TAMPER terminal. In this way a single pair of wires is used for the two alarms.

- **DIP4 = ON** The sensor uses the TAMPER terminal in case of anti-masking.
- **DIP4 = OFF** The sensor uses the MASK clamp in case of anti-masking

ACTIVE ALARM LED IN NORMAL MODE

To activate the ALARM LEDS in normal operation:

- put **DIP1 = ON** and close the cover
- wait until the sensor exit automatically from walk-test (about 15 min): the sensor returns to NORMAL mode
- now the ALARM LED is active, signaling the alarm events that occur during the measurements

ATTENTION: THE SENSOR IS OPERATIVE ONLY WITH THE COVER! After each modification of the dyps and trimmers it is necessary to close the cover and wait for at least 3 seconds during which the sensor reads the settings.

11

PROTECTION FROM TAMPER

The sensor is protected against tampering attempts by means of three controls: anti-opening of the cover, anti-removal and anti-masking.

ANTI-OPENING

Protection against opening of the sensor cover.

ANTI-REMOVAL

Protection against removal from the installation position. Protection activated by the inclinometer on the sensor. Pay attention to the installation instructions to avoid inaccurate reporting

To exclude this protection act on the INCLINOMETER JUMPER:

- closed = Inclinometer active
- open = Inclinometer disabled.

SENSITIVITY

The sensitivity of the infrared and the microwave are regulated together by the trimmer. Turn the trimmer clockwise to increase the sensitivity. Active thermal compensation automatically adjusts the sensor to maximize yield in the most critical temperatures. To delimit the detection zone more precisely, it is advisable to mount the sensor with the correct inclination, in order to better define the detection area. Although the thermal compensation acts on the detection algorithm, adapting the behavior according to the detected temperature, the sensor can slightly alter the behavior according to the climatic conditions.

12

DUEVI s.r.l. - Via Bard 12/A, 10142 TORINO - ITALY
Made in Italy
 Il presente manuale può essere soggetto a modifiche senza preavviso



Ai sensi del D.LGS N° 49 del 14 marzo 2014 "Attuazione della Direttiva 2012/19/UE sui rifiuti di apparecchiature elettriche ed elettroniche (RAEE)". Il simbolo del cassonetto barrato riportato sull'apparecchiatura indica che il prodotto alla fine della propria vita utile deve essere raccolto separatamente dagli altri rifiuti e conferito presso idonei centri di raccolta differenziata dei rifiuti elettronici ed elettrotecnici. Lo smaltimento abusivo del prodotto da parte dell'utente comporta l'applicazione delle sanzioni amministrative di cui al D.LGS n. 49 del 14/03/2014.

15

16